

Nero® Collection



We take the worry out of
protecting what's valuable to you.
Lockwood: *no worries*®



ASSA ABLOY

www.lockweb.com.au

Contents



Entrance
Handles
page 4



Velocity® Large Rose
Element Lever
page 7



Velocity® Small Rose
Leversets
page 10



Velocity® Small Rose
Escutcheons
page 14



Cavity Sliding
Door Lock
page 16



FP2
Flush Pull
page 18



724 Series
Slide Arm Door Closer
page 20



Nexion® Mechanical
Entrance Lockset
page 22



Paradigm® Pull Handle
Lockset - Deadbolt
page 26



Paradigm® 005
Double Cylinder Deadbolt
page 29

Contents



Paradigm® 005

Latching

page 33



Symmetry®

Key in Lever

page 36



001 Double

Cylinder Deadlatch

page 39



Symmetry®

Double Cylinder

page 42



100®

Nightlatch

page 44



355

Deadlock

page 46

Entrance Handles



Lockwood Entrance Handles are constructed using the finest materials to incorporate the maximum standards in style, durability, finish and design.

Style and Variety

Combining fit for purpose with the epitome of style, the Lockwood Entrance Handles offers a high quality solution to the requirements of both residential and commercial markets.

Packaging For Various Doors

Comes supplied with spigots to suit 10 – 12mm thick glass doors as well as aluminium and timber doors up to 50mm thick.

Application

Suitable for use on timber or aluminium frame as well as glass doors; making them the ideal choice for commercial, industrial and residential applications.

Multi Fix - timber, aluminium or glass doors

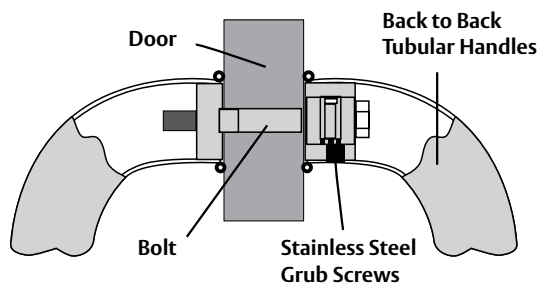

Product Details

Materials

Stainless Steel Construction: Constructed of 304 grade stainless steel, suitable for use in external environments

Standards and Compliance



Disabled Access - AS1428.1

Entrance Handles

141 Series

Dimensions

	A	B1	B2	C	D	E
141x300MBK	300mm	22mm	40mm	45mm	450mm	25mm
141x600MBK	600mm	22mm	40mm	45mm	750mm	25mm

Fixing

Timber 2 x 80mm M8 Bolts - 8.5mm hole

Glass 2 x 40mm M8 Bolts - 13mm hole



Disabled Accessible AS1428.1

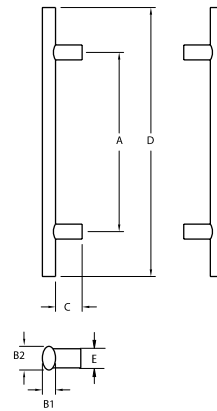

141X600MBK

142

Dimensions

	A	B	C	D	E
142x300MBK	300mm	32mm	45mm	450mm	25mm
142x450MBK	450mm	32mm	45mm	600mm	25mm

Fixing

Timber 2 x 80mm M8 Bolts - 8.5mm hole

Glass 2 x 40mm M8 Bolts - 13mm hole



Disabled Accessible AS1428.1

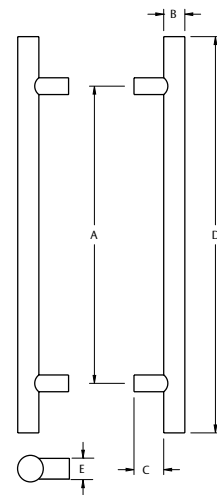

142X450MBK

143

Dimensions

	A	B1	B2	C	D
143x450MBK	450mm	30mm	15mm	35mm	465mm
143x600MBK	600mm	30mm	15mm	35mm	615mm

Fixing

Timber 2 x 62mm M6 Bolts - 8.5mm hole

Glass 2 x 32mm M6 Bolts - 13mm hole



Disabled Accessible AS1428.1

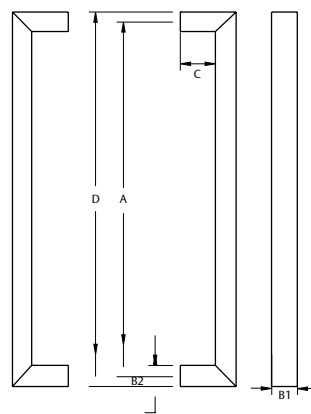

143X600MBK

Entrance Handles

145

Dimensions

	A	B	C	D	E
145x225MBK	225mm	25mm	45mm	300mm	19mm

Fixing

Timber 2 x 70mm M8 Bolts - 8.5mm hole

Glass 2 x 30mm M8 Bolts - 13mm hole



Disabled Accessible AS1428.1

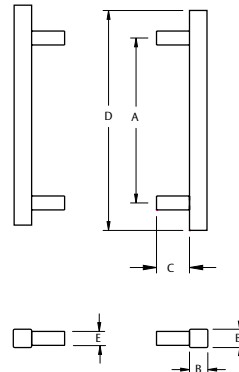

145X225MBK

146

Dimensions

	A	B	C	D	E	F
146x450MBK	450mm	25mm	60mm	475mm	60mm	25mm
146x600MBK	600mm	25mm	60mm	625mm	60mm	25mm

Fixing

Timber 2 x 80mm M8 Bolts - 8.5mm hole

Glass 2 x 40mm M8 Bolts - 13mm hole



Disabled Accessible AS1428.1

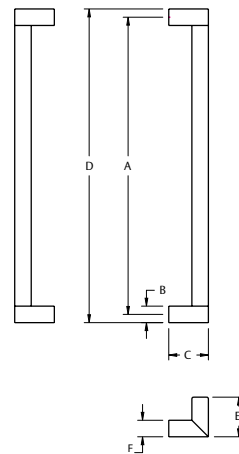

146X600MBK

Velocity® Series Large Rose Door Furniture



The Velocity Series is a stylish range of door furniture suitable for use in residential dwellings.

Designed to suit common door preparations in the Australian market, Velocity is ideal for both new and retrofit applications.

Retrofitable

Fits majority of doors with 54mm hole.

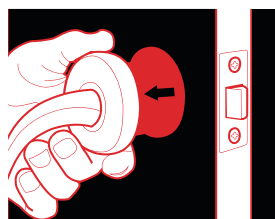

1 Align **2 Twist** **3 Tighten**



Features and Specifications

- All fixings are concealed beneath a removable rose trim providing a crisp and clean presentation desired by the discerning home owner
- Simple twist and tighten fixing method with pre-assembled lever set allows for super easy and fast installation
- The rose fits 50mm or 54mm diameter holes making it suitable for retrofit and common door preparations
- Designed in Australia for the specific needs of the Australian market

Product Details

Rose Dimensions 63mm by 12.5mm.

Materials Solid zinc die-cast with steel rose trims

Latches Passage sets are available with a 60mm backset tubular latch. Privacy sets are supplied with a 60mm backset privacy latch which includes an activating pin for the inside of the door and an external emergency release function. The latch is automatically released when the internal handle is operated and is easily adapted for both open in and open out applications. All latches are supplied with industry standard "D" strikes.

Door Thickness 32mm to 45mm hinged doors

Finishes Matt Black (MBK)

Standards and Compliance

D5 Tested to AS4145.2 2008 for Durability passing D5 - 100,000 cycles.



Tested to AS4145.2 2008 for Neutral Salt Spray, passing C6 - 168 hours.

Not suited to coastal applications

Velocity® Series Large Rose Door Furniture

Element™ – Lever 3

Length	122mm
Projection	54.5mm
Finger Clearance	47.5mm

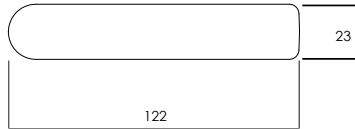
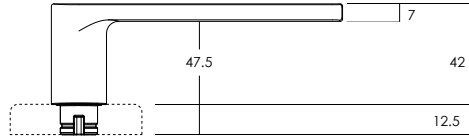

Passage Leverset

Part Number	VEL1/L3MBK
--------------------	------------

Dummy Lever

Part Number	VEL3/L3MBK
--------------------	------------



Privacy Leverset

Part Number	VEL2/L3MBK
--------------------	------------



Passage Leverset

Part Number	VEL1/37MBKDP
--------------------	--------------



Disabled Accessible
AS1428.1



*Available in Display Pack Only

Velocity® Series Large Rose Door Furniture

Privacy Leverset

Part Number VEL2/37MBKDP



Disabled Accessible
AS1428.1

*Available in Display Pack Only



Square Rose Passage Trim

Part Number VES1-TRIMMBK

* Pack of 2

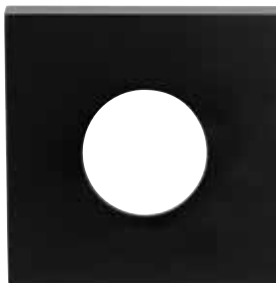

Square Rose Privacy Trim

Part Number VES2-TRIMMBK

* Pack of 2

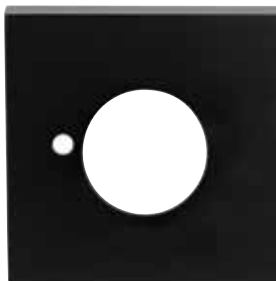

Velocity® Series Small Rose Door Furniture



The Velocity Small Series is a stylish range of door furniture suitable for both residential and semi-commercial applications. Designed primarily for new installation on timber doors, the range incorporates functionality for use with Mortice Locks in addition to Passage, Privacy and Dummy Levers.

Installation

Suits door thickness range of 32mm to 45mm.

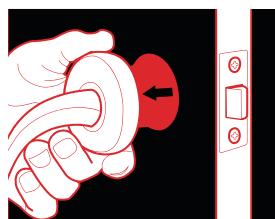

1 **Align** 2 **Twist** 3 **Tighten**



Features and Specifications

- All fixings are concealed beneath a removable rose trim providing an aesthetically appealing installation
- Simple twist and tighten fixing method with pre-assembled lever set allows for super easy and fast installation
- Choose from two lever designs, the ever popular Element L3 lever and the AS1428.1 compliant Dianella L8 lever
- Accessories include AS1428.1 compliant turn, standard turn and privacy indicating emergency turns
- The 55mm rose suits up to 45mm door thickness commonly used with mortice locks or latches
- Designed in Australia for the specific needs of the Australian market

Product Details

Rose Dimensions	55mm by 12.5mm - Round Rose 58mm by 12.5mm - Square Rose
Materials	Solid zinc die-cast lever with steel rose trims
Latches	Passage sets are available with a 60mm backset tubular latch. Privacy sets are supplied with a 60mm backset privacy latch which includes a locking pin for the inside of the door and an external emergency release function. The latch is automatically released when the internal handle is operated and is easily adapted for both open in and open out applications. All latches are supplied with industry standard "D" and "T" strikes.
Door Thickness	32mm to 45mm hinged doors
Finishes	Matt Black (MBK)

Standards and Compliance



Successfully tested up to 2 hours on fire door assemblies in accordance with the Australian Standard AS1905.1 2005 - Part 1: Fire Resistant Doorsets when used with Lockwood Synergy or Selector mortice locks

D8

Tested to AS4145.2 2008 for Durability passing D8 - 500,000 cycles



Tested to AS4145.2 2008 for Neutral Salt Spray, passing C6 - 168 hours



AS1428.1 Compliance. The range includes AS1428.1 compliant levers and turns

Velocity® Series Small Rose Door Furniture

Element™ - Lever 3

Length	122mm
Projection	54.5mm
Finger Clearance	47.5mm

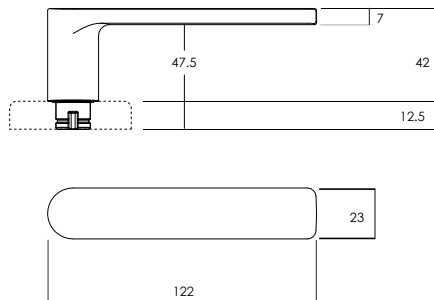

Mortice Lock Leverset

Part Number	VSR0/L3MBK
--------------------	------------

Passage Leverset

Part Number	VSR1/L3MBK
--------------------	------------

Dummy Lever

Part Number	VSR3/L3MBK
--------------------	------------



Privacy Leverset

Part Number	VSR2/L3MBK
--------------------	------------



Velocity® Series Small Rose Door Furniture

Dianella™ - Lever 8

Length 121mm

Projection 51mm

Finger Clearance 38mm



Disabled Accessible
AS1428.1

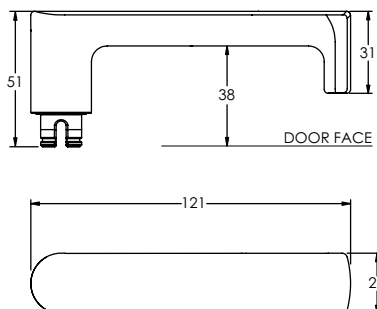

Mortice Lock Leverset

Part Number VSR0/L8MBK

Passage Leverset

Part Number VSR1/L8MBK



Privacy Leverset

Part Number VSR2/L8MBK



Velocity® Series Small Rose Door Furniture

Square Rose Passage Trim

Part Number VSS1-TRIMMBK

* Pack of 2

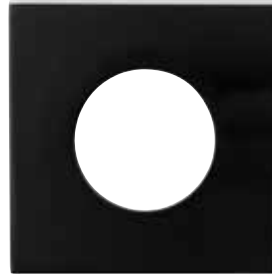

Square Rose Privacy Trim

Part Number VSS2-TRIMMBK

* Pack of 2

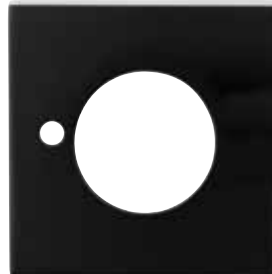

Velocity® Series Small Rose Door Furniture

Euro Cylinder Escutcheon

Part Number	VSR5/MBK
Height	55mm
Depth	12.5mm

Supplied with
2x Wood Screws

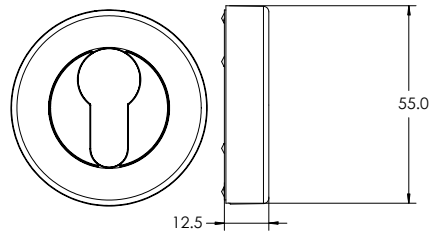

Oval Cylinder Escutcheon

Part Number	VSR6/MBK
Height	55mm
Depth	12.5mm

Supplied with
2x Wood Screws

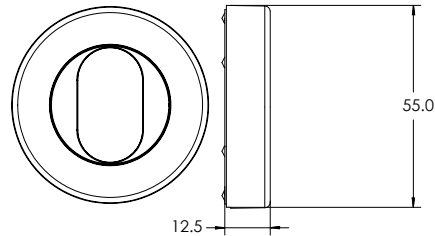

Standard Turnknob

Part Number	VSR7/MBK
Height	55mm
Depth	12.5mm

Handing Not required

Supplied with
2x Wood Screws
1x Short Tail Bar
1x Medium Tail Bar
1x Tail Bar Spring
1x Instructions (1220-321)

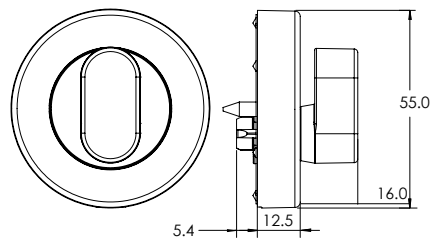

Privacy Indicating Emergency Turn

Part Number	VSR8/MBK
Height	55mm
Depth	12.5mm

Supplied with
2x Wood Screws
1x Emergency Tail Bar
1x Instructions (1220-321)

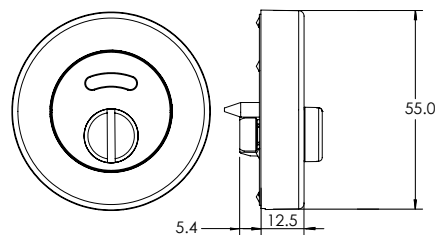

Velocity® Series Small Rose Door Furniture

Disabled Accessible Turnknob

Part Number VSR9/MBK

Height 55mm

Depth 12.5mm

Turn Snib Length 52mm

Handing Site handable

Supplied with

- 2x Wood Screws
- 1x Tail Bar (short)
- 1x Tail Bar (medium)
- 1x Tail Bar Spring
- 1x Instructions (1220-321)

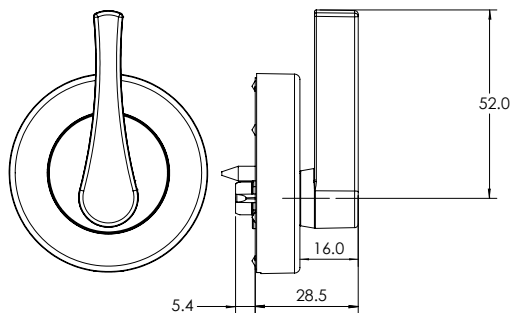

Square Rose Escutcheon Trim

Part Number VSS6-TRIMMBK

* Pack of 2

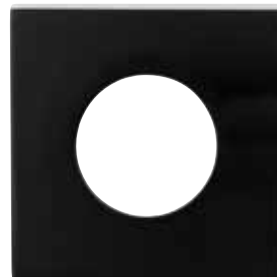

Cavity Sliding Door Lock



The Lockwood sliding door lock range is possibly the most innovative and aesthetically pleasing lock for a cavity sliding door in Australia. Combining elegance and ease of use, the Lockwood Cavity Sliding Door Lock range is ideal for any home décor and security solution.

Available in entrance, passage and privacy models, it offers the perfect solution for residential bathroom sliding doors.

Features and Specifications

- Fitted flush against the panel of the sliding door for full recess into the door cavity

Retractable door pull

Designed after extensive research, the sliding cavity door lock features an innovative retractable door pull which combines style with functionality.

Product Details

Cross Drill	25mm
Door Thickness	32* to 40mm for timber doors *Requires spacer ring (included)
Finishes	Matt Black (MBK)
Latch Backset	60mm
Prep Hole	54mm
Strike	Box strike or pip strike (passage)
Materials	Furniture plate: Zinc Alloy Bolt: Nickel Plated Zinc (12.4mm projection) Bolt Beak: Stainless Steel Front End Plate: Stainless Steel Retractable Door Pull: Zinc Plated Strike Plate: Stainless Steel Strike Box: Zinc Plated

Cavity Sliding Door Lock

7400 Privacy Set

Part Number	Finish
7400MBKDP	Matt Black

Outside

Emergency release button opened by coin or screwdriver

Inside

Locked or unlocked by turn-plate

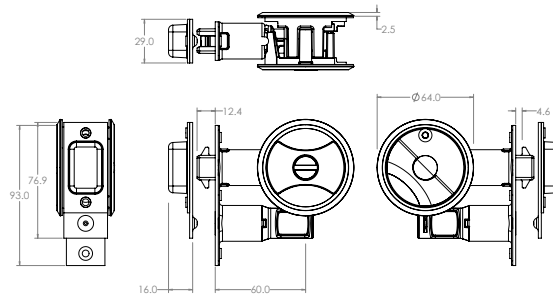

Exterior

Interior

7444 Entrance Set

Part Number	Finish
7444MBKDP	Matt Black

Outside

Locked or unlocked by key

Inside

Locked or unlocked by turn-plate

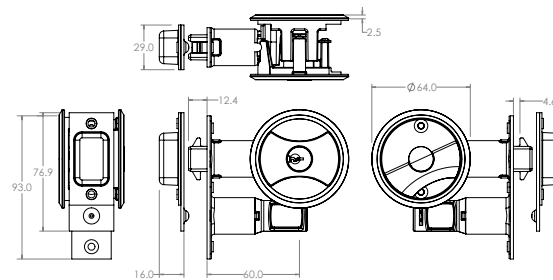

Exterior

Interior

7450 Passage Set

Part Number	Finish
7450MBKDP	Matt Black

Outside

Free to slide door at all times

Inside

Free to slide door at all times

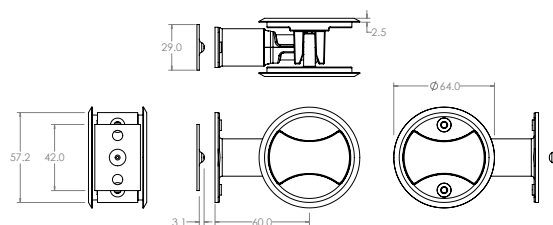

Exterior

Interior

FP2 Flush Pull



The Lockwood Nero® Flush Pull offers multiple solutions for flush mount door furniture.

Application

Suited to numerous applications which require the door furniture to be flush with the surface of the door.

Product Details

Materials	Zinc Stainless Steel
------------------	-------------------------

Standards and Compliance

C6

These products have been successfully tested in accordance with AS 2331-3.1: 2001. Neutral Salt Spray Test (NSS TEST).
Passing C6 Corrosion Resistance - 168 hours

FP2 Flush Pull

FP2-150

Dimensions	Packaging	Part Number
------------	-----------	-------------

150 x 50mm	Trade	FP2-150MBK
------------	-------	------------

Features and Specifications

- Stainless steel flush pull
- Trade packed, complete with fixing screws

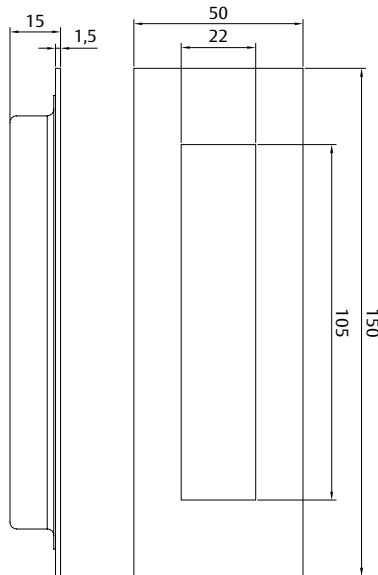

724 Series Slide Arm Door Closer



The Lockwood Rack & Pinion Slide Arm Series provides for a cleaner, more aesthetic appearance on the door whilst utilizing the same robust features and benefits of Rack and Pinion functionality.

Specifications

Power	EN adjustable 2 to 4
Back check (BC)	Adjustable
Hold Open	Adjustable. Hold-open can be set at any angle up to 150° of opening
Handing	Non-handed. Suitable for left or right hand doors
Cover	Clip-on
Materials	Extruded aluminium body manufactured from high-performance silicon alloy
Mechanism	Rack and pinion design
Mounting	Regular, parallel and over-door
Valves	Adjustable closing and latching speed valves with overload protection.

Standards and Compliance



Tested on fire door assemblies up to 4 hours in accordance with Australian Standard AS1905.1-1997, Part 1: Fire Resistant Doorsets The Lockwood 724SR series closer has been successfully tested upto four hours (depending on type of doorset) on fire door assemblies in accordance with Australian Standard AS1905.1:2005, Part: Fire Resistant Door sets.

Note: Hold open option is not approved on any fire door.

724 Series Slide Arm Door Closer

724SR Slide Arm Pull Side

Part Number

724SRBLK

Closer installed on pull side of door. This mounting position permits opening of 130°.

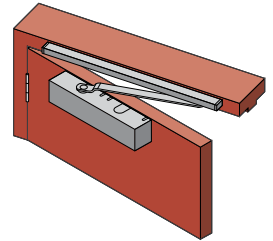
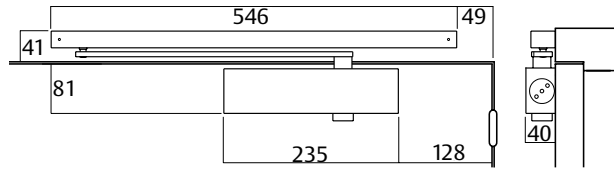

7724SR Slide Arm Push Side

Part Number

724SRBLK

Closer installed on push side of door. This mounting position permits opening of 115°.

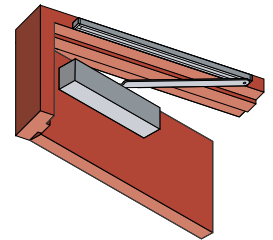
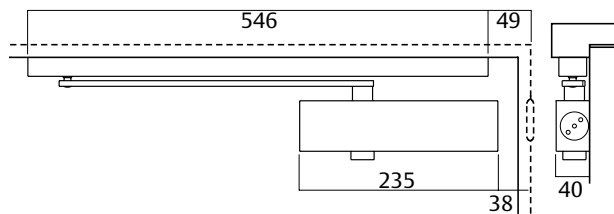

7724SR Slide Arm Over Door Mounting Push Side

Part Number

724SRBLK

Closer installed on push side of door and top rail where conditions do not allow parallel mounting. This mounting position permits opening of 115°.

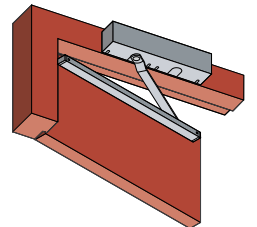
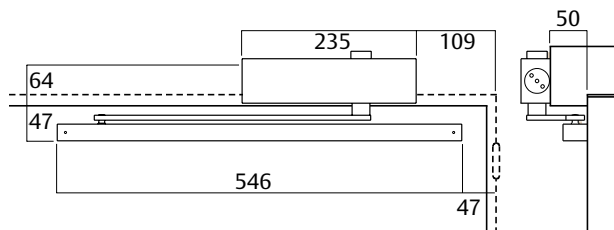

Nexion® Mechanical Entrance Lockset



The Nexion Entrance Lockset represents the next generation in home security.

Designed and manufactured to the highest standards of quality, the Lockwood Nexion has set the benchmark for safety, security and style. The Nexion offers the ultimate protection for your home and family.

Features and Specifications

- Three mode security: Secure, Safety and Passage mode provides excellent security without compromising convenience
- LockAlert® indicator shows lock status at a glance
- SafetyRelease™ automatically unlocks the inside handle upon entry to minimise the risk of being locked in
- High security latch
- Box strike with concealed crossgrain door frame strengthening screw
- Can be keyed alike to other Lockwood door locks as well as builder's key systems

Product Details

Backset	60mm as supplied 70mm optional (order part 530-222SC)
Case	High purity zinc alloy
Door Thickness	35 to 45mm
Finishes	Matt Black (MBK)
Handles	Element Lever 3
Latch	13mm projection brass bolt
Strike	Box strike with concealed crossgrain door frame strengthening screw
Templates	Installation template included
Handing	Adjustable handing by set screw
Cylinder	Internal and external 5 pin tumbler mechanism with 6 pin capability Brass cylinders and brass barrels

Standards and Compliance



The locksets can be optioned to suit fire door sets with a fire resistance level of up to 1 hour on fire door assemblies in accordance with Australian Standard AS1905.1:2005 Fire Resistant Doorsets. The fire rated option is achieved with a standard Nexion Vision Entrance Lockset and the optional fire rated kit (order NXVFRKIT).

SL7 (Security) Australian Lock Standard (AS4145.2.2008)

D8 (Durability) Australian Lock Standard (AS4145.2.2008)

C5 (Corrosion) Australian Lock Standard (AS4145.2.2008)

CE CE Approved

C C-tick certified

Nexion® Mechanical Entrance Lockset

Keying

- Supplied individually keyed with two keys per lock
- 78,000 key combinations
- Key blank KB401B5P

Restricted Special Keying

Lockwood locks can be keyed to a number of controlled and/or specially keyed systems. These range from legally protected keys to protect against unauthorised duplication, which can also include specially designed key systems such as master key systems, which allow for different levels of mechanical access control.

Please refer to Lockwood Keying Catalogue or contact your local sales office or customer service for specific information.

Latch Dimensions

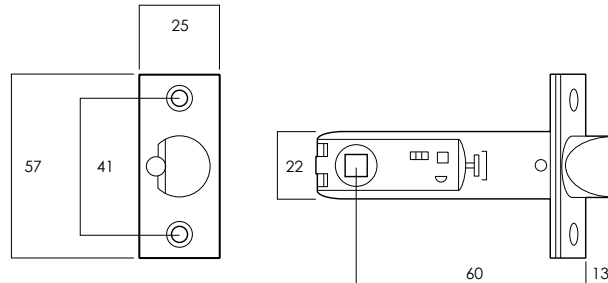

Kinetic Defence®
Bump and pick resistant.



Deadlatch Bolt
13mm projection
brass bolt.



SafetyRelease™
Minimises the risk of being
locked in.



2 Keys Included
Can be keyed alike to other
Lockwood door locks.



LockAlert®
Interior Indicator shows lock
status at a glance.



Quick Installation
Suitable for door thicknesses
between 35–45mm.



Safety Mode
Securely locked from outside
and free from inside.



Retrofittable
Fits majority of doors with
54mm hole.



Secure Mode
Securely locked from both
inside and outside. For when
nobody is home.



Passage Mode
Free to enter from outside
and free to exit from inside.

Nexion® Mechanical Entrance Lockset

Nexion Vision - Double Cylinder



Exterior



Interior

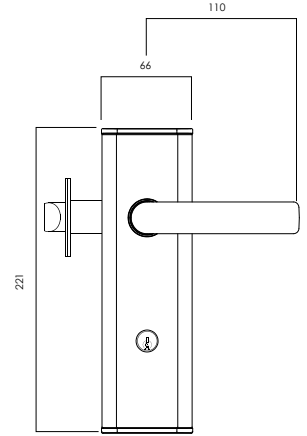
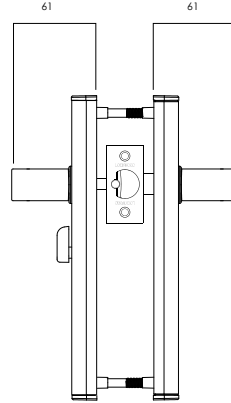
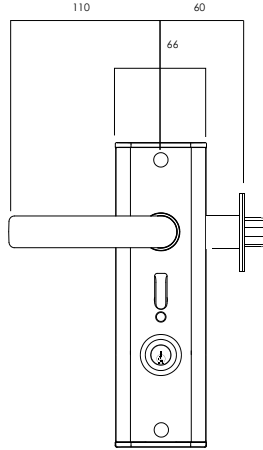

Nexion® Mechanical Entrance Lockset

Ordering Procedure

Series	Function	Cylinders	App. Options	Levers	Finish	Keying
NXV	1	2	1	L3	MBK	-
Series	Cylinders	Levers	Keying			
Nexion Vision NXV	Double 2	Element L3	Keyed to Differ (Standard) -			
Function	Application Options	Finish				
Mechanical 1	Timber Frame Strike* 1	Matt Black MBK	Keyed Alike 5 Pins 5KA			
			Project Keyed 5 Pins 5PK			
			Restricted Profile 5 Pins 5RP			
			Keyed Alike 6 Pins 6KA			
			Project Keyed 6 Pins 6PK			

*Metal Frame T-Strike optional (order part NX8/40SC)

*For Fire Rated Nexion Vision option (order part NXVFRKIT)

Paradigm® Pull Handle Lockset - Deadbolt



The Australian designed Paradigm® Pull Handle Lockset expresses superior state-of-the-art design featuring a contemporary style that delivers exceptional safety and security.

Suitable for residential, new building and renovation market applications.

The Pull Handle lockset incorporates innovative safety features from the Paradigm 005 Deadbolt and is manufactured with high end 304 grade stainless steel that comes in a Matt Black finish.

Key Features

- Three function modes with DualSelect® provides combination of convenience and security
- High security cut resistant stainless steel bolt
- High end 304 grade stainless steel and resilient, long-lasting Matt Black finish Pull Handle
- Concealed screw fixings gives a neat and clean appearance
- Safety Release™ automatically unlocks internal knob upon key entry from outside
- LockAlert® indicator shows lock status at a glance

Restricted Special Keying

Lockwood locks can be keyed to a number of controlled and/or specially keyed systems. These range from legally protected keys to protect against unauthorised duplication, which can also include specially designed key systems such as master key systems, which allow for different levels of mechanical access control.

Please refer to Lockwood Keying Catalogue or contact your local sales office or customer service for specific information.

Product Details

Dimensions	External handle length - 600mm Internal handle length - 500mm Handle width - 30mm
Backset	60mm-70mm adjustable
Bolt	High security cut resistant
Cylinder	5 pin tumbler mechanism Brass cylinder and brass barrel
Door Thickness	32 - 48mm 32-36mm doors require a spacer (Included)
Finishes	Matt Black (MBK)
Materials	304 Grade Stainless Steel
Strike	Box strike with concealed crossgrain door frame strengthening screw
Magnets	Door Magnets included to hold the door(s) in position when in passage mode (free to enter from outside and free to exit from inside)
Keying	<ul style="list-style-type: none"> • Supplied individually keyed with two keys per lock • 78,000 key combinations • Key blank KB2015P

Standards and Compliance

SL8	(Security) Australian Lock Standard (AS4145.2 - 2008)
D8	(Durability) Australian Lock Standard (AS4145.2 - 2008)
C6	(Corrosion) Australian Lock Standard (AS4145.2 - 2008)
K5	(Key Security) Australian Lock Standard (AS4145.2 - 2008)

Paradigm® Pull Handle Lockset - Deadbolt

Pull Handle Lockset

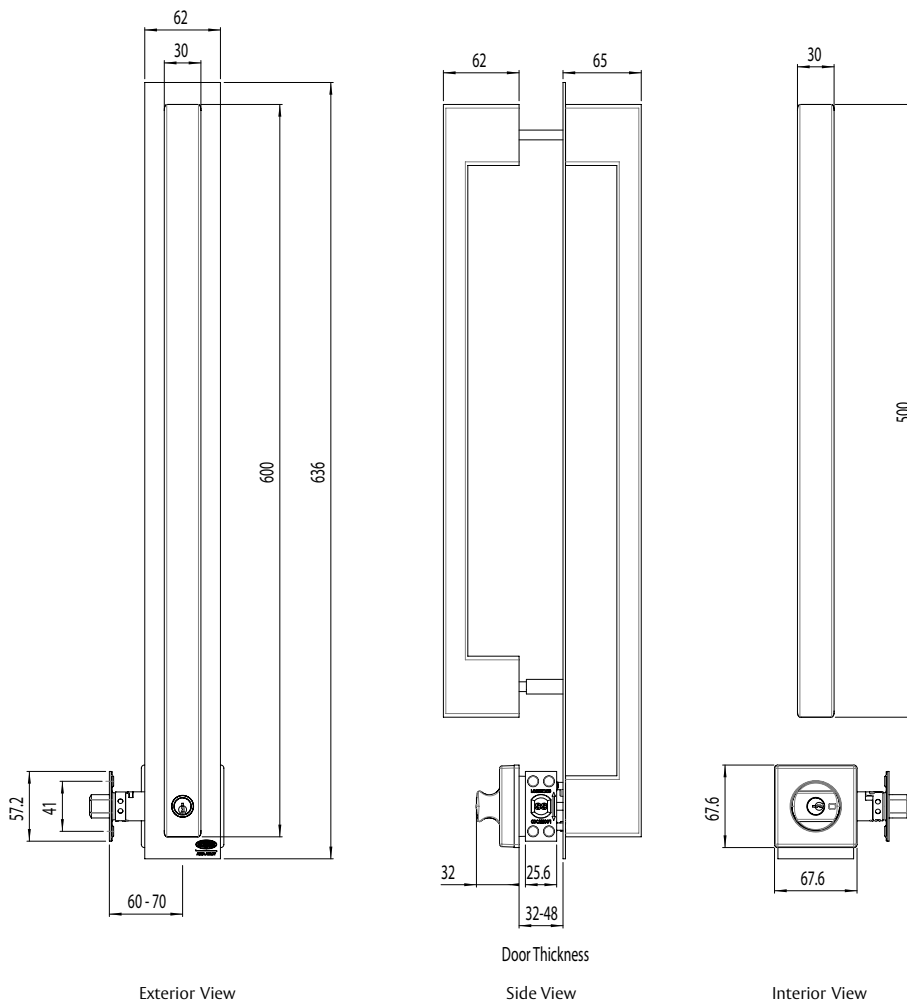

Paradigm Pull Handle Lockset		Keying Options	
Part Number		Key to differ (standard)	
005/DPHBMBK		Special Keying-Residential Keyed Alike 5P	5KA
		Project Keyed 5P	5PK
		Restricted Profile 5P	5RP

Paradigm® Pull Handle Lockset - Deadbolt



DualSelect®
Turn the key for safety mode. Turn the key further to select secure mode.



SafetyRelease™
Minimises the risk of being locked in.



Corrosion Resistant
Successfully tested in accordance with AS2332.3.1:2001 neutral salt spray test.



Kinetic Defence®
Bump and pick resistant.



Counterbalance Bolt
Proportionally distributes the load between the door and door frame.



2 Keys Included
Can be keyed alike to other Lockwood door locks.



Door Thickness
32mm to 48mm.



LockAlert®
Interior Indicator shows lock status at a glance.



Safety Mode
Securely locked from outside and free from inside.



Secure Mode
Securely locked from both inside and outside. For when nobody is home.



Passage Mode
Free to enter from outside and free to exit from inside.

Paradigm® 005 Cylinder Deadbolt



The Paradigm® 005 Double Cylinder Deadbolt is the premium security solution with its innovative safety features. The contemporary styling can be combined with any lever or entrance handle to create an elegant security solution, ideal for residential and architectural applications.

Key Features

- Three function modes with DualSelect® provides combination of convenience and security
- High security cut resistant stainless steel bolt
- Safety Release™ automatically unlocks internal knob upon key entry from outside
- LockAlert® indicator shows lock status at a glance
- Available in round or square rose

Restricted Special Keying

Lockwood locks can be keyed to a number of controlled and/or specially keyed systems. These range from legally protected keys to protect against unauthorised duplication, which can also include specially designed key systems such as master key systems, which allow for different levels of mechanical access control.

Please refer to Lockwood Keying Catalogue or contact your local sales office or customer service for specific information.

Retrofitable

Replace your existing Deadbolt. Fits 54mm hole. 60-70mm adjustable backset. 32-48mm door thickness.

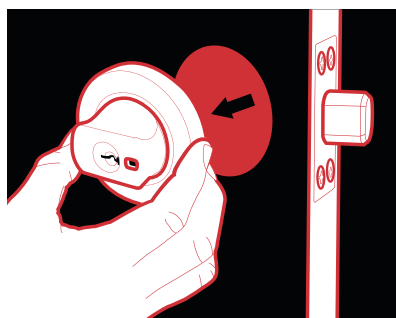

Product Details

Backset	60 to 70mm adjustable stainless steel bolt
Bolt	High security, cut resistant stainless steel bolt
Cylinder	5 pin tumbler mechanism Brass cylinder and brass barrel
Door Thickness	32–48mm 32–36mm doors require a spacer (Included)
Finishes	Matt Black (MBK)
Keying	Supplied individually keyed with two keys per lock, 78,000 key combinations, Key blank KB401B5P
Materials	High purity zinc alloy
Strike	Box strike with concealed crossgrain door frame strengthening screw

Standards and Compliance

SL8	(Security) Australian Lock Standard (AS4145.2 - 2008)
D8	(Durability) Australian Lock Standard (AS4145.2 - 2008)
C6	(Corrosion) Australian Lock Standard AS4145.2 - 2008)
K5	(Key Security) Australian Lock Standard AS4145.2 - 2008)

Paradigm® 005 Cylinder Deadbolt

Round Rose



Exterior



Interior

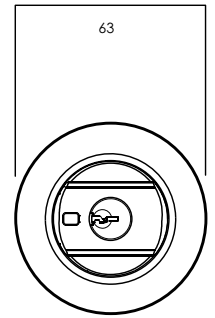
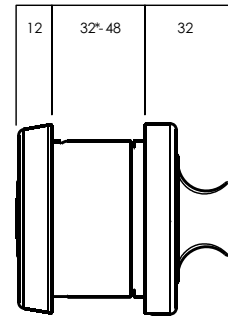
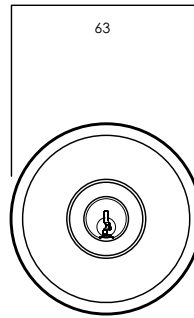

*32–36mm door thickness requires spacer ring (included)



Kinetic Defence®
Bump and pick resistant.



Counterbalance Bolt
Proportionally distributes the load between the door and door frame.



DualSelect®
Turn the key for safety mode. Turn the key further to select secure mode.



2 Keys Included
Can be keyed alike to other Lockwood door locks.



SafetyRelease™
Minimises the risk of being locked in.



Retrofitable
Replace your existing Deadbolt. Fits 54mm hole. 60-70mm adjustable backset. 32-48mm door thickness.



Anti-Corrosion
Successfully tested in accordance with AS2332.3.1:2001 neutral salt spray test.



LockAlert®
Interior Indicator shows lock status at a glance.



Safety Mode
Securely locked from outside and free from inside.



Secure Mode
Securely locked from both inside and outside. For when nobody is home.



Passage Mode
Free to enter from outside and free to exit from inside.

Paradigm® 005 Cylinder Deadbolt

Square Rose



Exterior



Interior

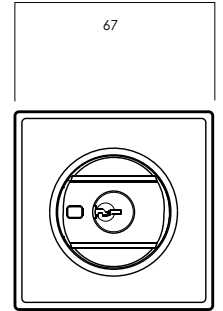
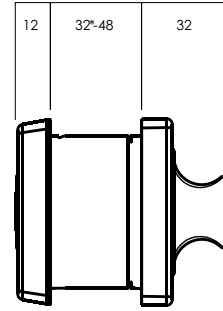
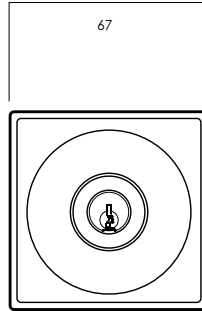

*32–36mm door thickness requires spacer ring (included)



Kinetic Defence®
Bump and pick resistant.



Counterbalance Bolt
Proportionally distributes the load between the door and door frame.



DualSelect®
Turn the key for safety mode. Turn the key further to select secure mode.



2 Keys Included
Can be keyed alike to other Lockwood door locks.



SafetyRelease™
Minimises the risk of being locked in.



Retrofitable
Replace your existing Deadbolt. Fits 54mm hole. 60-70mm adjustable backset. 32-48mm door thickness.



Anti-Corrosion
Successfully tested in accordance with AS2332.3.1:2001 neutral salt spray test.



LockAlert®
Interior Indicator shows lock status at a glance.



Safety Mode
Securely locked from outside and free from inside.



Secure Mode
Securely locked from both inside and outside. For when nobody is home.



Passage Mode
Free to enter from outside and free to exit from inside.

Paradigm® 005 Cylinder Deadbolt

Ordering Procedure

Series	Type	Rose Style	Finish	Packaging	Keying
005	B	1	MBK	DP	
Series	Rose Style	Packaging			
Paradigm® 005	Round 1 Square 2	Universal Pack DP Trade Pack			
Type	Finish	Keying Options			
Bolt B	Matt Black MBK	Special Keying-Residential Keyed Alike 5P 5KA Keyed Alike 6P 6KA Project Keyed 5P 5PK Project Keyed 6P 6PK Restricted Profile 5P 5RP			

* For keying options please contact customer service.

Latching Paradigm® 005



The Lockwood Latching Paradigm® 005 is the premium security solution with its innovative safety features. It has a holdback function which keeps the latch in the retracted position when required. The contemporary styling can be combined with any lever or entrance handle to create an elegant security solution, ideal for residential and architectural applications.

Key Features

- Holdback function keeps the latch in the retracted position when required
- High security cut resistant Stainless Steel latch
- Concealed screw fixings for a neat and clean appearance
- Safety Release™ function minimises the risk of being deadlatched inside

Restricted Special Keying

Lockwood locks can be keyed to a number of controlled and/or specially keyed systems. These range from legally protected keys to protect against unauthorised duplication, which can also include specially designed key systems such as master key systems, which allow for different levels of mechanical access control.

Please refer to Lockwood Keying Catalogue or contact your local sales office or customer service for specific information.

Retrofitable

Replace your existing Deadlatch. Fits 54mm hole. 60mm backset. 32-48mm door thickness.

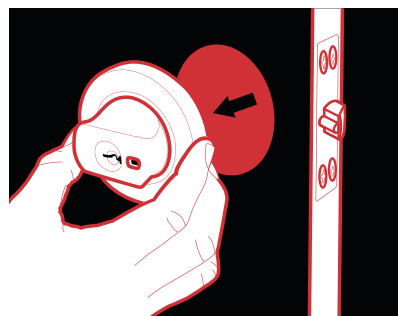

Product Details

Backset	60 mm stainless steel deadlatch
Latch	High security, cut resistant stainless steel latch
Cylinder	5 pin tumbler mechanism Brass cylinder and brass barrel
Door Thickness	32–48mm 32–36mm doors require a spacer (Included)
Finishes	Matt Black (MBK)
Keying	Supplied individually keyed with two keys per lock, 78,000 key combinations, Key blank KB401B5P
Materials	High purity zinc alloy
Strike	Box strike with concealed crossgrain door frame strengthening screw

Latching Paradigm® 005

Round Rose



Exterior



Interior

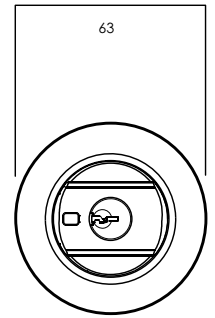
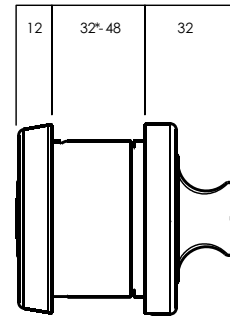
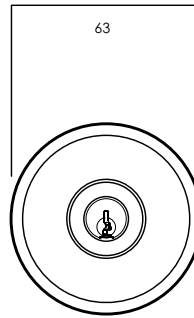

*32–36mm door thickness requires spacer ring (included)



Kinetic Defence®
Bump and pick resistant.



Door Thickness
32mm-48mm



SafetyRelease™
Minimises the risk of being locked in.



2 Keys Included
Can be keyed alike to other Lockwood door locks.



Retrofitable
Replace your existing Deadlatch.
Fits 54mm hole. 60mm backset.
32-48mm door thickness.



Holdback Mode
Keep the latch in the retracted position when required.



Safety Mode
Securely locked from outside and free from inside.



Secure Mode
Securely locked from both inside and outside. For when nobody is home.

Latching Paradigm® 005

Ordering Procedure

Series	Type	Rose Style	Finish	Packaging	Keying
005	L	1	MBK	DP	
Series		Rose Style		Packaging	
Paradigm® Deadbolt	005	Round	1	Universal Pack	DP
Type		Finish		Keying Options	
Latch	L	Matt Black	MBK	Special Keying-Residential Keyed Alike 5P	5KA
				Keyed Alike 6P	6KA
				Project Keyed 5P	5PK
				Project Keyed 6P	6PK
				Restricted Profile 5P	5RP
* For keying options please contact customer service.					

Symmetry® Key in Lever



The Symmetry door handle range offers builders, developers, specifiers and interior designers a wide selection of product that can be used in any residential application

The Symmetry series is produced to meet the demanding quality and style requirements of the Australian market.

All products are tested in accordance with the security and durability requirements of the Australian Standards.

Along with the Lockwood 25 year Mechanical Warranty all Symmetry door furniture is supplied with a 5 year finish Guarantee with the exception of the Everbrass finish which has a 25 year finish Guarantee.

Keying

Standard Keying

- Supplied individually keyed with three keys per lock
- 78,000 key combinations
- Key blank KB401B5P

Restricted Special Keying

Lockwood locks can be keyed to a number of controlled and/or specially keyed systems. These range from legally protected keys to protect against unauthorised duplication, which can also include specially designed key systems such as master key systems, which allow for different levels of mechanical access control. Please refer to Lockwood Keying Catalogue or contact your local sales office or customer service for specific information.

Product Details

Backset	60 to 70mm adjustable latch standard
Cylinder	5 pin Lockwood C4 brass cylinder assembly (6 pin compatible)
Functions	Entrance, privacy, passage and dummy available
Handing	Suitable for left and right handed doors
Installation	Easy to install with detailed mounting instructions
Latch	13mm throw
Strike	D-strike with anti-rattle tab as standard

Symmetry 5 Year Finish Guarantee



Lockwood guarantees to replace Symmetry product if within five years from the proven date of purchase it tarnishes, discolours or corrodes when properly installed and subject to no more than fair wear and tear.

1 ONECYL®

The exclusive one cylinder assembly solution 'OneCyl®' has been designed for the entire Lockwood Symmetry Range, which grants the convenience of cylinder interchangeability.

Symmetry® Key in Lever

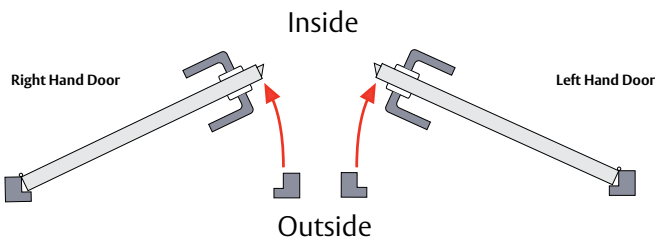

Symmetry® – Element™ Series

Part Numbers	Function
7550	Entrance
7551	Passage
7552	Privacy
7555	Dummy

Symmetry® – Element™ Leverset

Type	Tubular Latch
Materials	Key in Lever: Zinc Alloy Chassis: Steel Bolt head: Zinc
Fixing	Horizontal mounting screw fixing
Door Thickness	35–45mm for timber doors
Finish	Matt Black
Packaging	Trade Pack and Display Pack available

Symmetry® Key in Lever

Ordering Procedure

Locksets Series	Function	Finish	Packaging	Keying
755	0	SSS		KA
Lockset Series	Function	Finish	Packaging	Keying
Element™ 755	Entrance 0 Passage 1 Privacy 2 Dummy 5	Matt Black MBK	Display Pack DP Trade Pack TP	Special Keying-Residential Keyed Alike 5P 5KA Keyed Alike 6P 6KA Project Keyed 5P 5PK Projected Keyed 6P 6PK Restricted Profile 5P 5RP

001 Double Cylinder Deadlatch



The Australian-designed Lockwood 001® Deadlatch offers market-leading performance and reliability for your home.

The 001® Deadlatch features a cut-resistant stainless steel bolt, 11 concealed anchorage points and a door frame strengthener that combine to offer high security protection.

Additional features include a bolt holdback function that allows you to use your door in passage mode.

Features and Specifications

- Bolt holdback function activated by external key or internal knob
- Can be key locked in holdback position by key from inside
- Can be keyed alike to other Lockwood door locks
- Available in display pack

Keying

- Supplied individually keyed with two keys per lock
- 78,000 key combinations
- Key blank KB401B5P

Restricted Special Keying

Lockwood locks can be keyed to a number of controlled and/or specially keyed systems. These range from legally protected keys to protect against unauthorised duplication, which can also include specially designed key systems such as master key systems, which allow for different levels of mechanical access control.

Please refer to Lockwood Keying Catalogue or contact your local sales office or customer service for specific information.

Retrofitable

Replace your existing 001 Deadlatch.

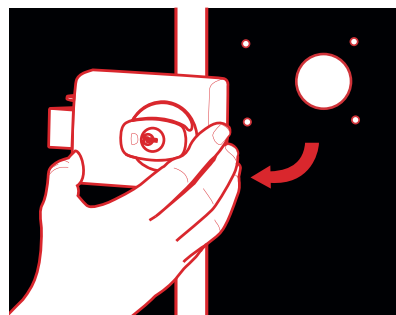

Product Details

Backset	60mm
Case	High purity zinc alloy
Cylinders	Internal and external 5 pin tumbler mechanism. Brass cylinders and brass barrels.
Door Thickness	30 - 45mm
Finish	Matt Black (MBK)
Latch	Stainless steel 18mm projection
Packers	3mm thick packer plates are available, these packers are installed under lock body to align lock body with face of jamb

Standards and Compliance

Conforms to Australian Standard (AS4145.2-2008 S,7D8C6)

001 Double Cylinder Deadlatch

Double Cylinder with Knob

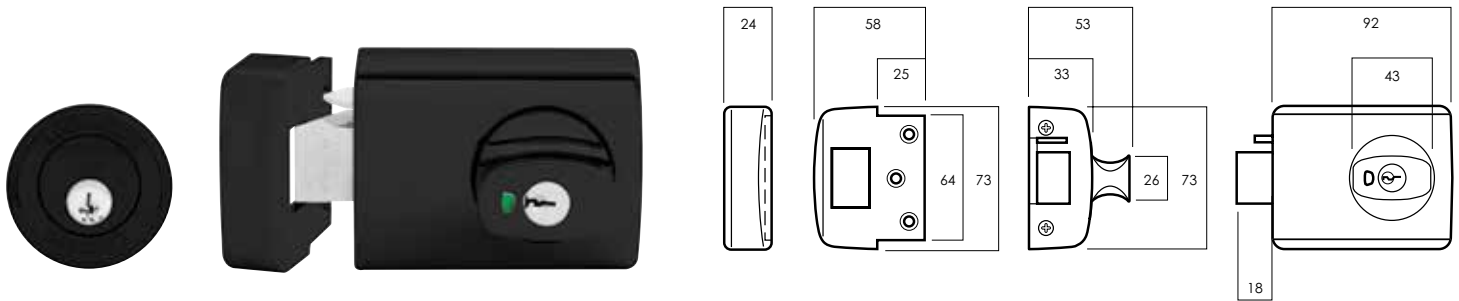

Exterior Cylinder

Interior



Kinetic Defence®
Bump and pick resistant.



2 Keys Included
Can be keyed alike to other
Lockwood door locks.



SafetyRelease™
Minimises the risk of being
locked in.



Retrofitable
Replace your existing
001 Deadlatch.



LockAlert®
Interior Indicator shows lock
status at a glance.



Safety Mode
Securely locked from outside
and free from inside.



Secure Mode
Securely locked from both
inside and outside. For when
nobody is home.



Passage Mode
Free to enter from outside
and free to exit from inside.



Deadlatch Bolt
Stainless steel 18mm projection.

001 Double Cylinder Deadlatch

001 - Knob with Open In Strike - Single Pack

Part Number	Finish
001-1K1MBKDP	Matt Black
001-1K1MBK	Matt Black

Suitable for INWARD opening timber framed doors.

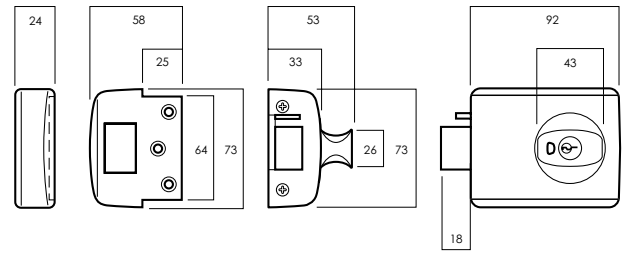

001 - Knob with Metal Frame Strike - Single Pack

Finish	Trade Pack
Satin Chrome Pearl	001-3K1SP
Matt Black	001-3K1MBK

Suitable for INWARD opening metal framed doors.

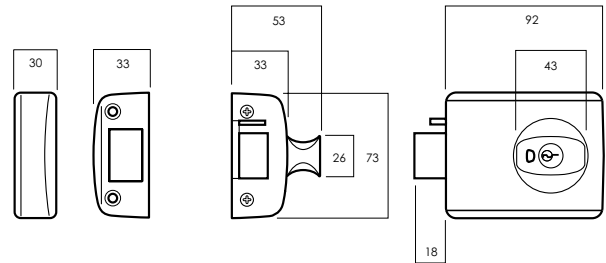

Symmetry® 7107 Double Cylinder Deadbolt



The Symmetry general purpose Deadbolts are standard security products that should be fitted with a Key in Knob or Key in Lever lockset for added safety and security.

Keying

- Supplied individually keyed with two keys per lock
- 78,000 key combinations
- Key blank KB401B5P

Restricted Special Keying

Lockwood locks can be keyed to a number of controlled and/or specially keyed systems. These range from legally protected keys to protect against unauthorised duplication, which can also include specially designed key systems such as master key systems, which allow for different levels of mechanical access control.

Please refer to Lockwood Keying Catalogue or contact your local sales office or customer service for specific information.

Bolt Dimensions

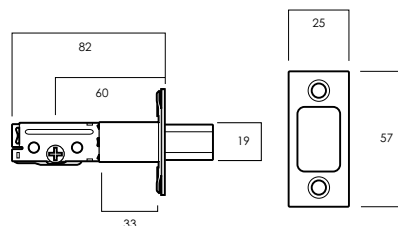

Retrofittable

Replace your existing Deadbolt. Fits 54mm hole. 60-70mm adjustable backset. 31-45mm door thickness.

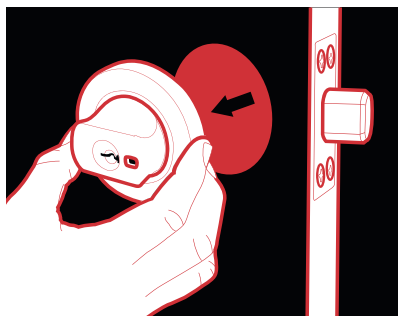

Product Details

Backset	60mm to 70mm adjustable bolt
Bolt	Solid brass bolt with 25mm projection. Hardened insert in locking bolt
Cylinder	The one cylinder assembly solution "OneCyl®" has been designed for the Lockwood Symmetry Range, which grants the convenience of cylinder interchangeability. C4 brass cylinder assembly (6 pin compatible)

Symmetry® 7107 Double Cylinder Deadbolt

Double Cylinder

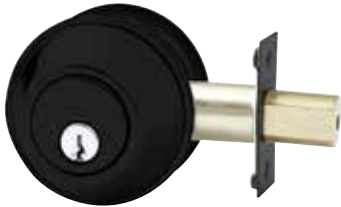

Exterior

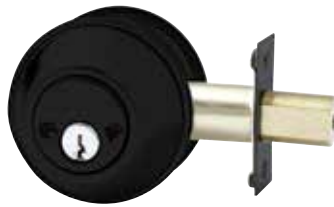

Interior

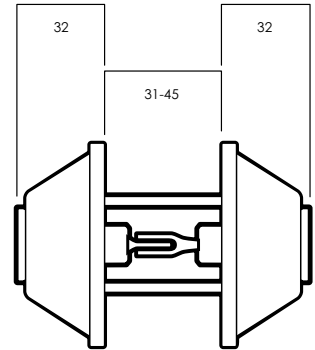
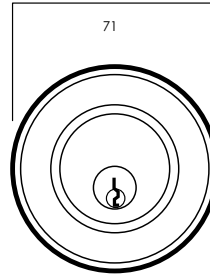

Kinetic Defence®
Bump and pick resistant.



2 Keys Included
Can be keyed alike to other
Lockwood door locks.



Retrofitable
Replace your existing Deadbolt. Fits
54mm hole. 60-70mm adjustable
backset. 31-45mm door thickness.

ONECYL® Cylinder Solution

Part Number	Finish
7107MBKDP	Matt Black
7107MBK	Matt Black

Product Details

Door Thickness	31mm to 45mm *31 to 41mm requires spacer ring (included)
Finish	Matt Black (MBK)
Handing	Suits left or right hand opening doors
Keying	Operated by key from both inside and outside

100 Nightlatch



General purpose nightlatch.

Features and Specifications

- Opened by key from outside and by turn knob inside
- Bolt may be held back by turning knob in clockwise direction

Keying

- Supplied individually keyed with two keys per lock
- 78,000 key combinations
- Key blank KB401B5P

Restricted Special Keying

Lockwood locks can be keyed to a number of controlled and/or specially keyed systems. These range from legally protected keys to protect against unauthorised duplication, which can also include specially designed key systems such as master key systems, which allow for different levels of mechanical access control.

Please refer to Lockwood Keying Catalogue or contact your local sales office or customer service for specific information.

Product Details

Backset	60mm
Case	High purity zinc alloy. 92mm wide, 64mm high, 43mm projection
Cylinder	5 pin tumbler mechanism Brass cylinder and brass barrel
Door Thickness	28 – 45mm
Latch	Brass. Reversible. 13mm projection
Finish	Lock Body : Matt Black (MBK) External Cylinder: Chrome Plate (CP)

100 Nightlatch

100



Exterior Cylinder

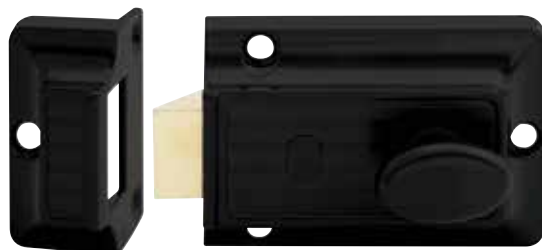

Interior

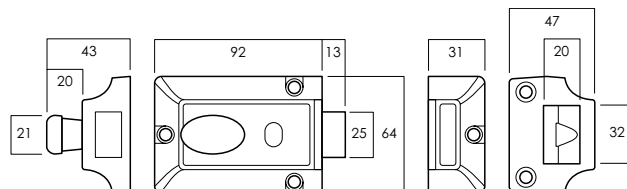

100 Nightlatch with Open In Strike

Finish	Display Pack
--------	--------------

Chrome Plate Cylinder	100MBKDP
-----------------------	----------

355 Double Cylinder Deadlock



The premium security features provided by the 355 Deadlock make it an ideal lockset for both domestic and commercial applications.

Opened by key from outside and by turn knob from inside when free. Internal key locks or unlocks turn knob.

Features and Specifications

- Suitable for hinged and some sliding doors
- Lockable turn knob with inbuilt clutching device to resist wrench attack
- Strong interlocking case and mounting plate to resist jemmy and hammer attack
- Concealed fixing
- Positive deadlocking action
- The mechanism and the design are protected by Australian and International Patents and Design Registrations

Keying

- Supplied individually keyed with two keys per lock
- 78,000 key combinations
- Key blank KB401B5P

Restricted Special Keying

Lockwood locks can be keyed to a number of controlled and/or specially keyed systems. These range from legally protected keys to protect against unauthorised duplication, which can also include specially designed key systems such as master key systems, which allow for different levels of mechanical access control.

Please refer to Lockwood Keying Catalogue or contact your local sales office or customer service for specific information.

Product Details

Backset	60mm
Bolt	Stainless steel
Case	Thick walled, high purity zinc alloy casting
Case Retainer Plate and Operating Mechanism	Solid pressed steel and diecast. Zinc components.
Cylinders	Internal and external 5 pin tumbler mechanism. Brass cylinders and brass barrels.
Door Thickness	30 - 45mm
Finish*	Matt Black (MBK)
Mounting Plate and Strike	Pressed steel
Packers	3mm thick packing plates installed under lock body to align lock body with face of jamb
Strike Conversion Plate	A strike conversion plate is required where the strike is to be installed in place of an existing flange strike

*Refer to next page for product range

Standards and Compliance

Conforms to Australian Standard (AS4145.2 - 2008 | S,7D8C6)

355 Double Cylinder Deadlock

Double Cylinder with Knob



Exterior Cylinder



Interior

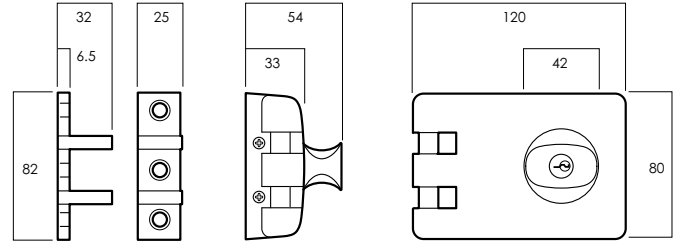

Kinetic Defence®
Bump and pick resistant.



2 Keys Included
Can be keyed alike to other
Lockwood door locks.



Retrofitable
Replace your existing
001 Deadlatch.

355 Double Cylinder Deadlock

Finish	Trade Pack	Display Pack
Matt Black	—	355-NMBKDP
Matt Black	355-NMBK	—

NERO[®]

COLLECTION



Master the Mood with Lockwood

The Lockwood Nero Collection provides a sensuous quality that complements contemporary décor; adding a defining design element to any space.



ASSA ABLOY

Lockwood is the leading brand in the Australian locking industry. With an established reputation for high quality products, this iconic brand provides a wide range of locking solutions to residential housing, commercial, semi-commercial, building and industrial application markets. Lockwood is supported by an extensive distribution and after-sales support network. Our customers include retailers, architects, trade and industrial personnel, locksmiths and security dealers.

ASSA ABLOY is the global leader in door opening solutions, dedicated to satisfying end-user needs for security, safety and convenience.

ASSA ABLOY is represented in all major regions, in both mature and emerging markets, with leading positions in Australia, Europe and North America.

**25YEAR
MECHANICAL
WARRANTY**

The Lockwood 25 Year Mechanical Warranty

Our belief that we manufacture the finest premium products available in today's market place is backed by the Lockwood 25 Year Mechanical Warranty, ensuring that Lockwood continues to keep Australians safe by delivering security and peace of mind.

For warranty terms and conditions, please visit www.lockweb.com.au or call **1300WARRANTY**

ASSA ABLOY Opening Solutions Australia
235 Huntingdale Road
Oakleigh, Victoria, 3166
Australia

1300 LOCK UP (1300 562 587)
lockweb.com.au

ASSA ABLOY New Zealand Ltd
6 Armstrong Road
Albany, Auckland, 0632
New Zealand

info.nz@assaabloy.com
Telephone +64 9415 7111
assaabloy.co.nz

Disclaimer

Whilst every effort has been made to ensure that the information (including product images and drawings) contained in this brochure is accurate at the time of publication, ASSA ABLOY Australia Pty Limited ("ASSA ABLOY") recommends that you consult ASSA ABLOY or its agents prior to placing an order to ascertain current information on specific products, as ASSA ABLOY reserves the right to make changes without notice. ASSA ABLOY will not be liable for any injury, loss or damage whatsoever, arising from any errors or omissions in the information contained in the brochure or arising from the use or application of the information contained herein. © 2023 copyright by ASSA ABLOY All rights reserved